

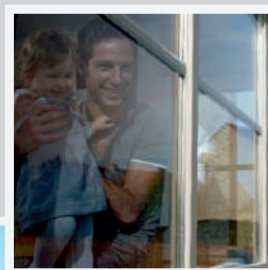

# PLATINIUM

Prospettive che salvaguardia leggerezza e luminosità

**QID**<sup>®</sup>  
QUALITÀ INNOVAZIONE DESIGN



Premio "INNOVATION AWARD"  
per l'innovazione nei prodotti ibridi.



**PLATINIUM** è il serramento di massima innovazione, che permette di realizzare finestre in PVC dal basso impatto ambientale e dal grande risparmio energetico. È un sistema con telaio a 5 camere con profondità 70 mm e anta a 6 camere con profondità 82 mm, rinforzi termici per il telaio e anta con fibra di vetro continua integrata. Spessore del vetro fino a 54 mm.

Attraverso la nuova tecnologia LINKTRUSION, integra nei telai principali, al posto dei tradizionali rinforzi in metallo, rinforzi termici, costituiti da una sagoma in PVC rigido, un cuore di PVC espanso e cavi in acciaio, mentre per le ante i rinforzi sono completamente sostituiti da fasci di fibra di vetro continua integrati all'interno delle pareti del profilo.

I serramenti **PLATINIUM** ti proiettano già nel futuro, verso il traguardo del 2020, quando le case passive e lo sviluppo sostenibile saranno un'inderogabile necessità.





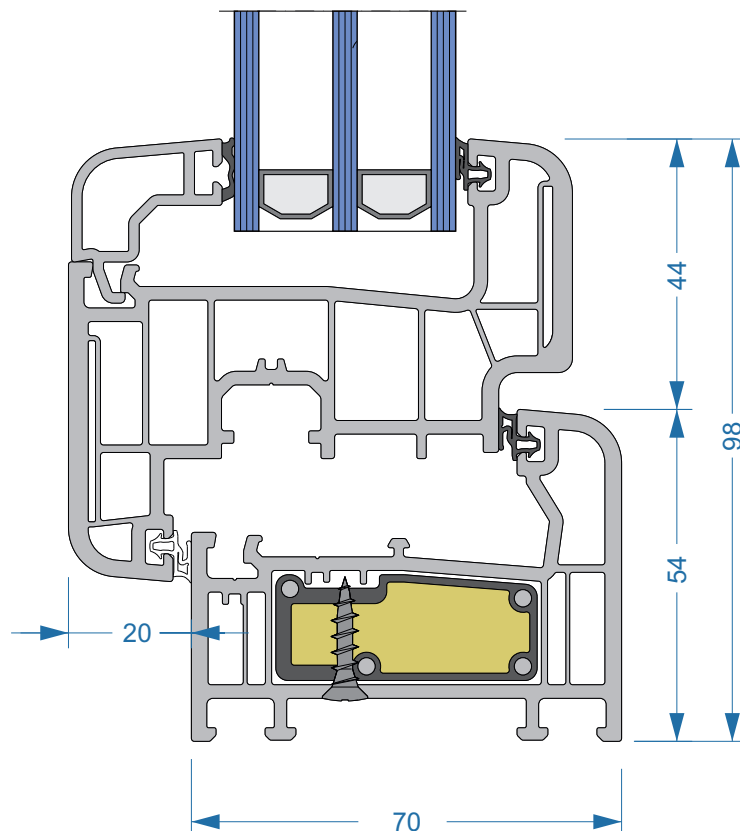

INFISSI  
ECOTERMOFIBRA



### CARATTERISTICHE TECNICHE

Telaio	sezione da 70mm
Anta	sezione da 82mm
Sormonto anta-telaio	8mm
Aletta appoggio vetro	20mm
Aletta battuta (anta)	20mm
Aletta battuta (telaio)	variabile (27mm - 40mm - 65mm)
Vetratura	Spessore vetro da 5 mm a 54mm

### PRESTAZIONI

ENERGIA		
	Isolamento termico	Uf=da 0,98 W/m <sup>2</sup> K
	Classificazione	Clima S
COMFORT		
	Permeabilità all'aria - EN 12207	Classe 4
	Tenuta alla pioggia - EN 12208	Classe 9A
	Resistenza ai carichi del vento - EN 12210	Classe C2

# PLATINIUM



## FINESTRE D'AUTORE

QID INFISSI S.R.L.  
Via Galileo Galilei, 22  
80027 Frattamaggiore (NA)  
Tel. +39 081 8805024  
P. Iva 07237281212

www.qidinfissi.it

